

SKM 145GB063DN



SEMITRANS™ 2N

Superfast NPT-IGBT Modules

SKM 145GB063DN

SKM 145GAL063DN

Features

- N channel, Homogeneous Silicon structure (NPT - Non punch-through IGBT)
- Low tail current with low temperature dependence
- High short circuit capability, self limiting if term. G is clamped to E
- Pos. temp.-coeff- of V_{CEsat}
- Very low C_{ies} , C_{oes} , C_{res}
- Fast & soft inverse CAL diodes
- Without hard mould
- Large clearance (10 mm) and creepage distances (20 mm)

Typical Applications

- Switching (not for linear use)
- Switched mode power supplies
- UPS
- AC inverter servo drives
- Pulse frequencies also above 10 kHz
- Welding inverters

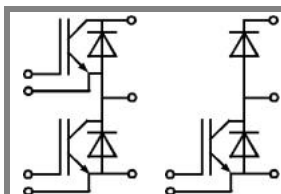

GB

GAL

Absolute Maximum Ratings		$T_c = 25\text{ }^\circ\text{C}$, unless otherwise specified	
Symbol	Conditions	Values	Units
IGBT			
V_{CES}		600	V
I_C	$T_c = 25\text{ (80) }^\circ\text{C}$	200 (140)	A
I_{CRM}	$t_p = 1\text{ ms}$	300	A
V_{GES}		± 20	V
T_{vj} (T_{stg})	$T_{OPERATION} \leq T_{stg}$	- 40 ... +150 (125)	$^\circ\text{C}$
V_{isol}	AC, 1 min.	2500	V
Inverse diode			
I_F	$T_c = 25\text{ (80) }^\circ\text{C}$	130 (90)	A
I_{FRM}	$t_p = 1\text{ ms}$	300	A
I_{FSM}	$t_p = 10\text{ ms}$; sin.; $T_j = 150\text{ }^\circ\text{C}$	880	A

Characteristics		$T_c = 25\text{ }^\circ\text{C}$, unless otherwise specified			
Symbol	Conditions	min.	typ.	max.	Units
IGBT					
$V_{GE(th)}$	$V_{GE} = V_{CE}$; $I_C = 3\text{ mA}$	4,5	5,5	6,5	V
I_{CES}	$V_{GE} = 0$; $V_{CE} = V_{CES}$; $T_j = 25\text{ (125) }^\circ\text{C}$		0,2	0,6	mA
$V_{CE(TO)}$	$T_j = (125)\text{ }^\circ\text{C}$		1,05 (1)		V
r_{CE}	$V_{GE} = 15\text{ V}$; $T_j = 25\text{ (125) }^\circ\text{C}$		7 (9,3)		m Ω
$V_{CE(sat)}$	$I_C = 150\text{ A}$; $V_{GE} = 15\text{ V}$; chip level		2,1 (2,4)	2,5 (2,8)	V
C_{ies}	under following conditions		8,4		nF
C_{oes}	$V_{GE} = 0$; $V_{CE} = 25\text{ V}$; $f = 1\text{ MHz}$		1		nF
C_{res}			0,6		nF
L_{CE}				25	nH
$R_{CC'+EE'}$	res., terminal-chip $T_c = 25\text{ (125) }^\circ\text{C}$		0,75 (1)		m Ω
$t_{d(on)}$	$V_{CC} = 300\text{ V}$; $I_C = 150\text{ A}$		130		ns
t_r	$R_{Gon} = R_{Goff} = 10\text{ }^\circ\Omega$; $T_j = 125\text{ }^\circ\text{C}$		65		ns
$t_{d(off)}$	$V_{GE} = \pm 15\text{ V}$		450		ns
t_f			40		ns
$E_{on} (E_{off})$			8,5 (5,5)		mJ
Inverse diode					
$V_F = V_{EC}$	$I_F = 150\text{ A}$; $V_{GE} = 0\text{ V}$; $T_j = 25\text{ (125) }^\circ\text{C}$		1,55 (1,55)	1,9	V
$V_{(TO)}$	$T_j = 125\text{ () }^\circ\text{C}$			0,9	V
r_T	$T_j = 125\text{ () }^\circ\text{C}$		6	8	m Ω
I_{RRM}	$I_F = 150\text{ A}$; $T_j = 125\text{ () }^\circ\text{C}$		53		A
Q_{rr}	$di/dt = A/\mu\text{s}$		8,1		μC
E_{rr}	$V_{GE} = 0\text{ V}$				mJ
FWD					
$V_F = V_{EC}$	$I_F = 150\text{ A}$; $V_{GE} = 0\text{ V}$; $T_j = 25\text{ (125) }^\circ\text{C}$		1,55 (1,55)	1,9	V
$V_{(TO)}$	$T_j = 125\text{ () }^\circ\text{C}$			0,9	V
r_T	$T_j = 125\text{ () }^\circ\text{C}$		6	8	m Ω
I_{RRM}	$I_F = 150\text{ A}$; $T_j = 125\text{ () }^\circ\text{C}$		53		A
Q_{rr}	$di/dt = 0\text{ A}/\mu\text{s}$		8,1		μC
E_{rr}	$V_{GE} = V$				mJ
Thermal characteristics					
$R_{th(j-c)}$	per IGBT			0,18	K/W
$R_{th(j-c)D}$	per Inverse Diode			0,5	K/W
$R_{th(c-s)}$	per module			0,05	K/W
Mechanical data					
M_s	to heatsink M6	3		5	Nm
M_t	to terminals M5	2,5		5	Nm
w				160	g

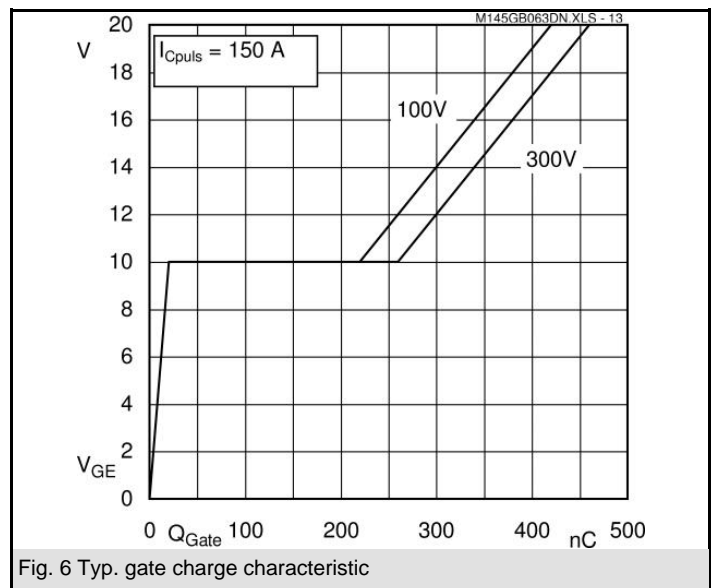
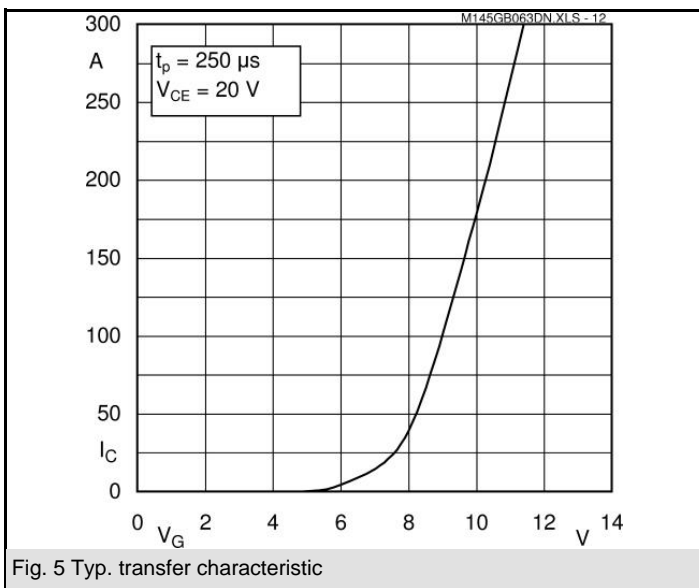
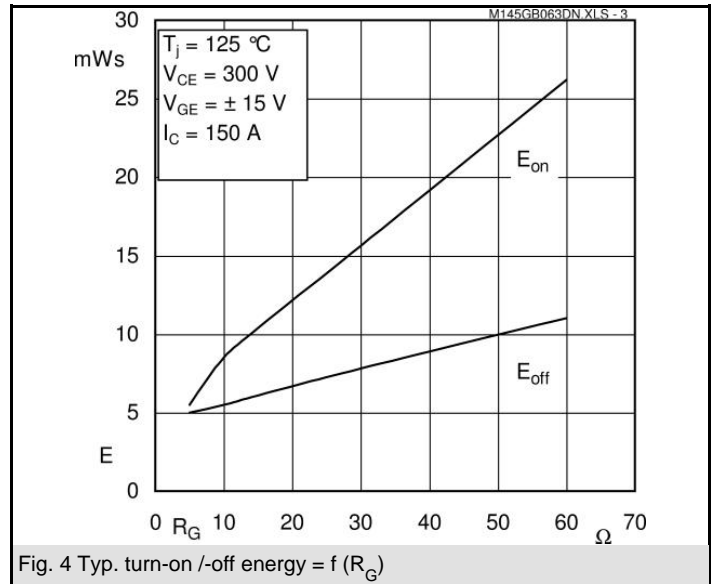
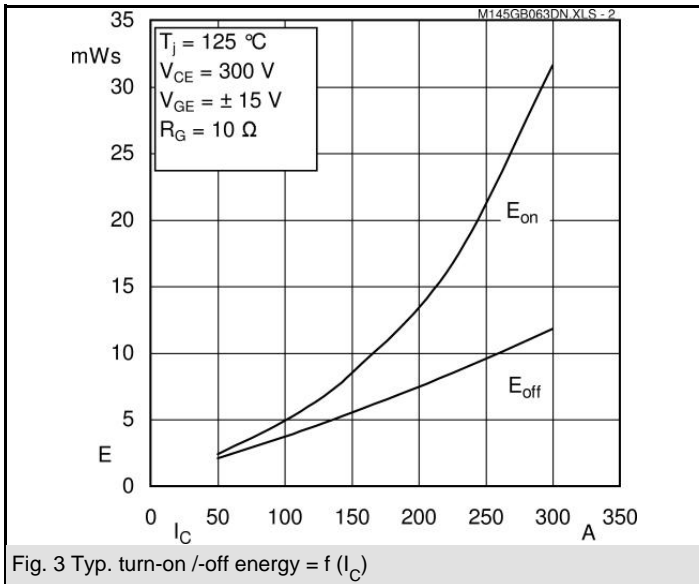
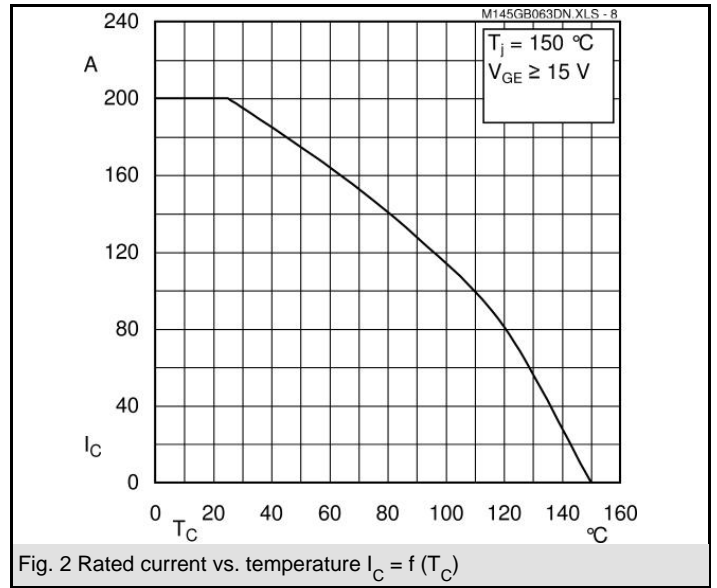
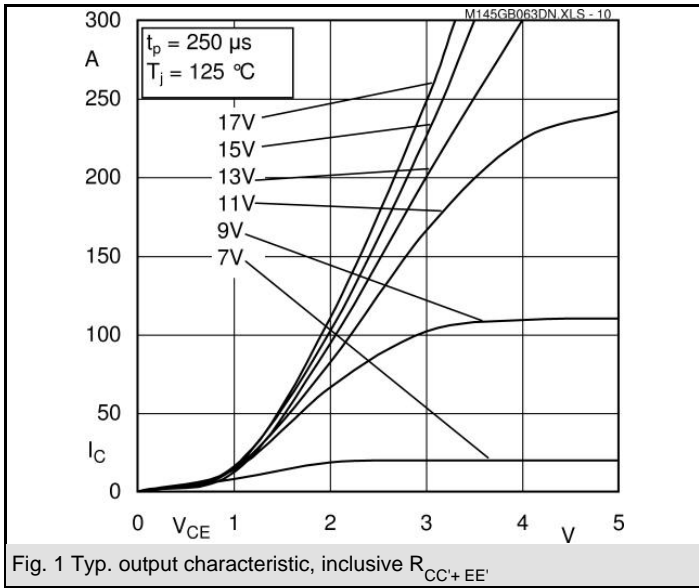

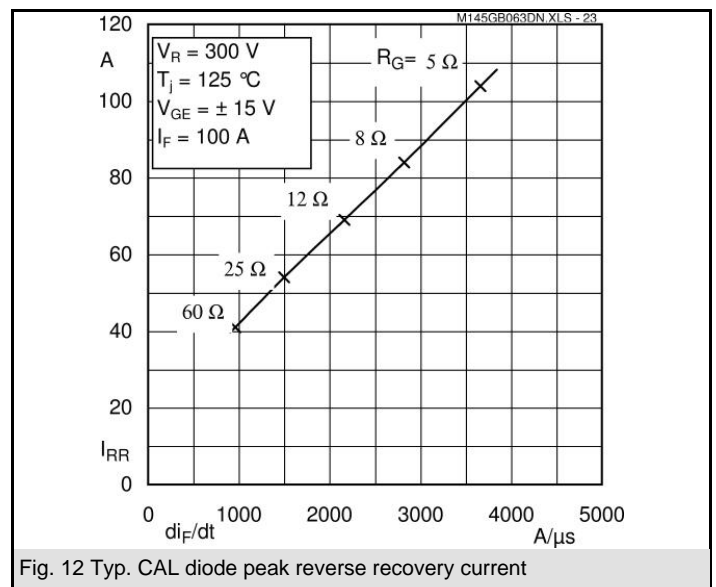
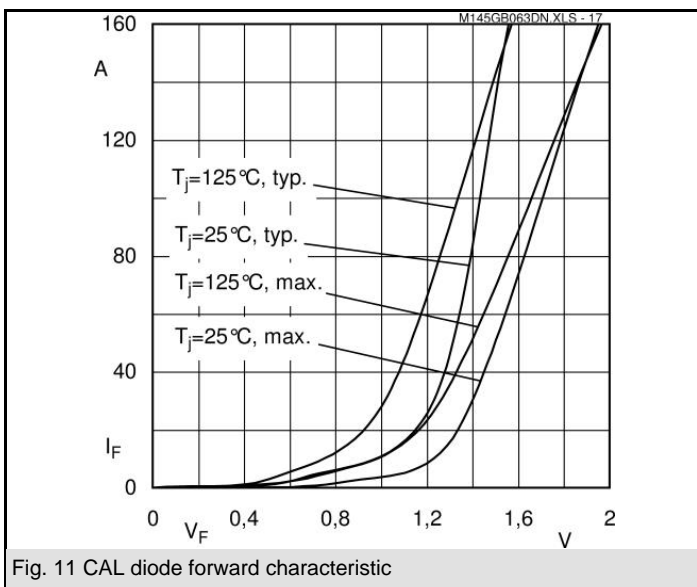
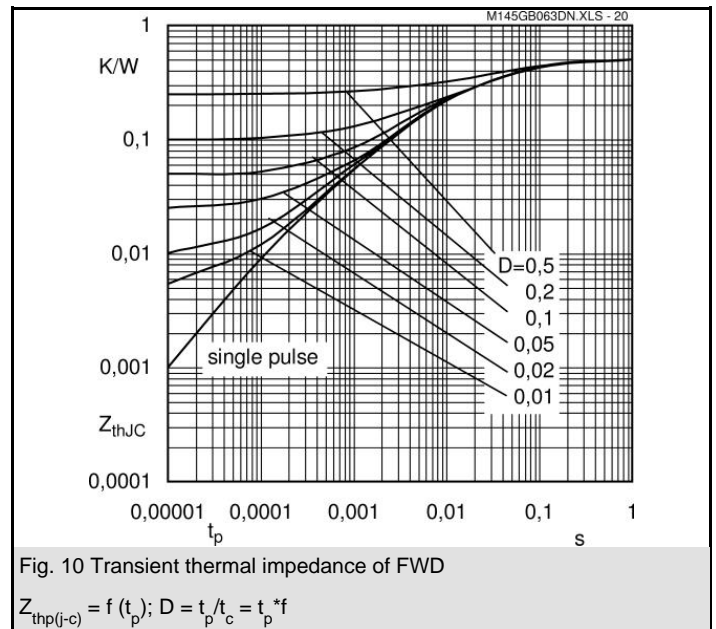
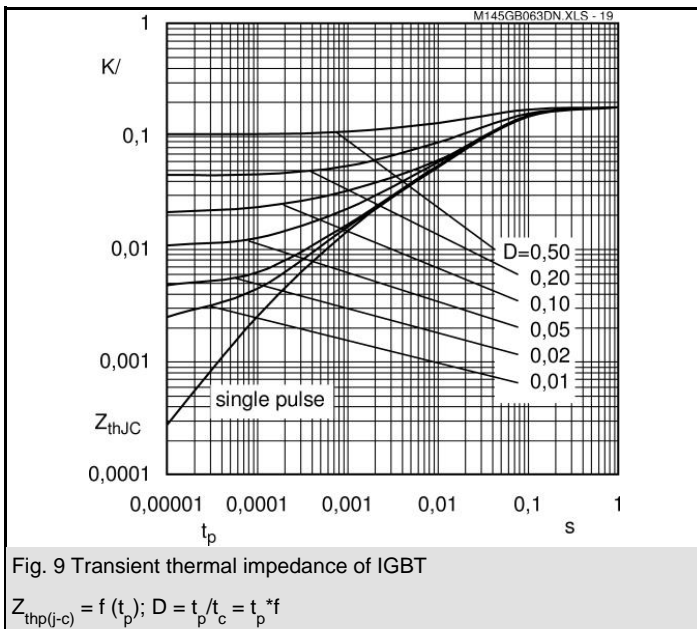
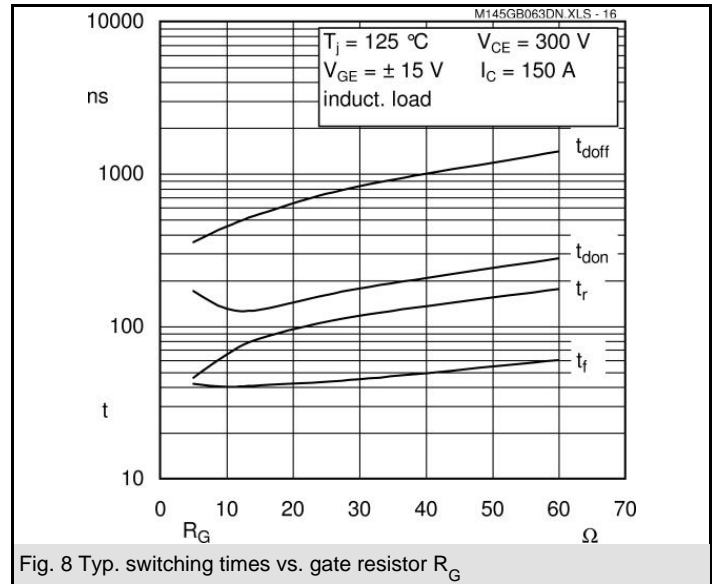
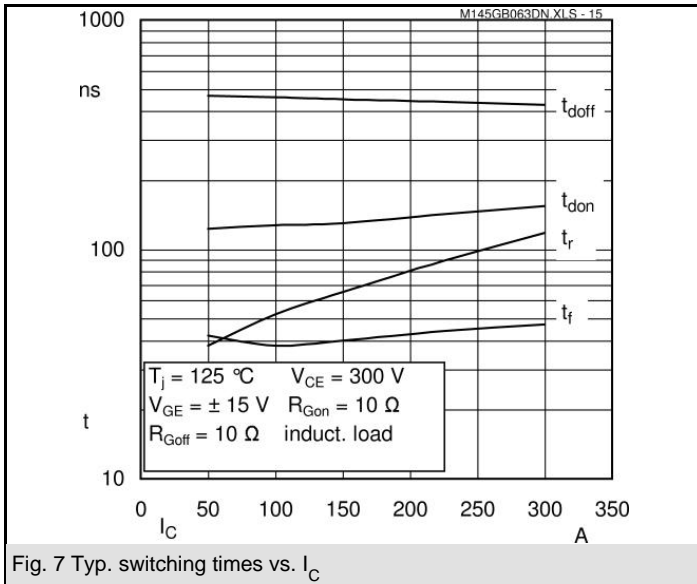

SKM 145GB063DN

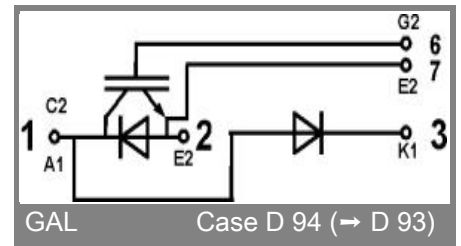
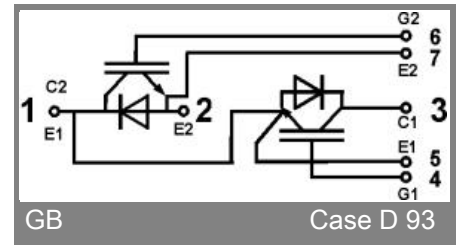
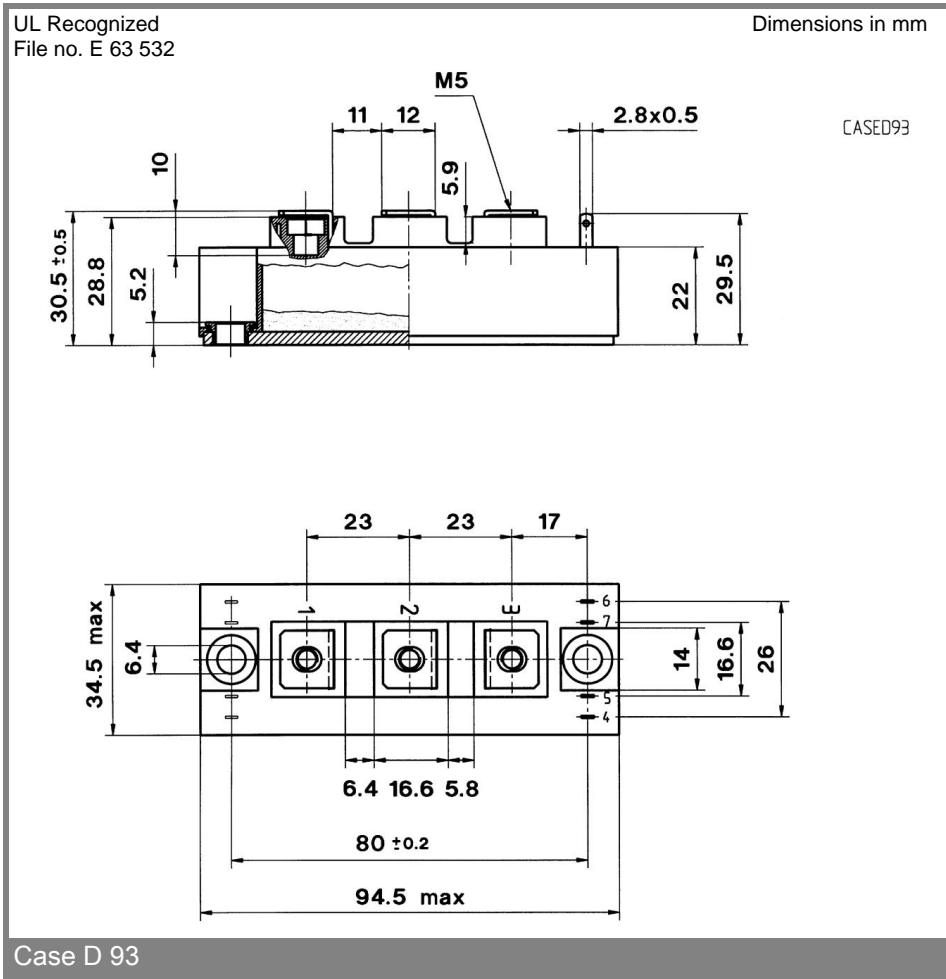
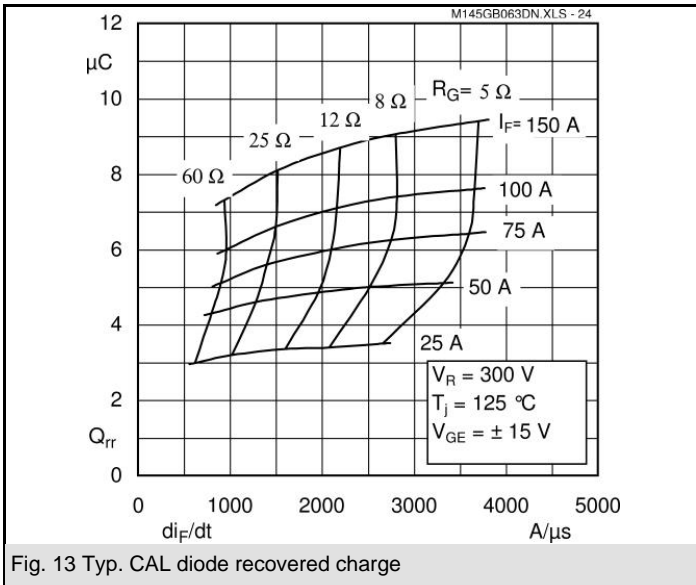

This is an electrostatic discharge sensitive device (ESDS), international standard IEC 60747-1, Chapter IX.

This technical information specifies semiconductor devices but promises no characteristics. No warranty or guarantee expressed or implied is made regarding delivery, performance or suitability.